

PASSIVE INFRARED DETECTOR

SAVER

Grade 2
EN50131-2-2

New Standard

The SAVER passive infrared detector offers a more economical means for experiencing Optex's leading sensing technologies.

SAVER delivers high catch performance through a dense Quad detection pattern, while the newly designed CORE platform delivers exceptional environmental stability. Suitable for commercial or residential applications, SAVER protects reputation and other valuables.



Quad Technology



Cost Effective

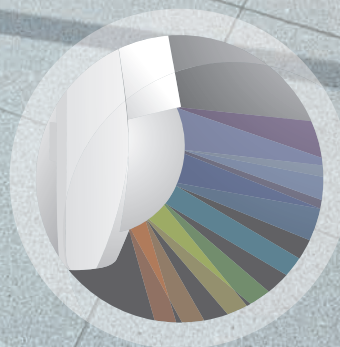

High Density Pattern



RFI Reduction

PASSIVE INFRARED DETECTOR

SAVER

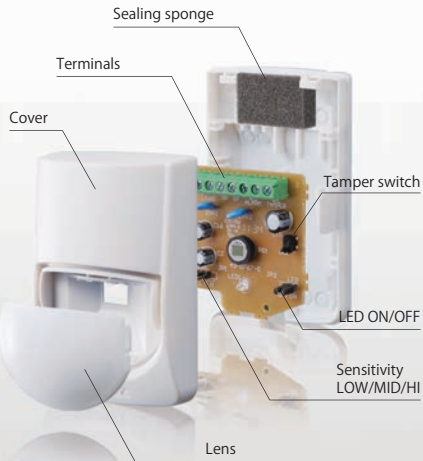

QUAD TECHNOLOGY

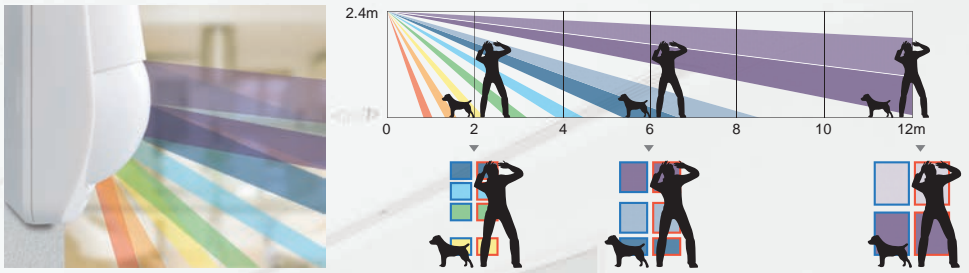

SAVER has a dense 156 edge, 78 zone detection pattern to enhance catch performance. The Quad optical system incorporates differing zone sizes to provide improved target recognition and reduce the incidence of non intruder activations. Digital intelligence allows SAVER to be used in numerous applications including areas where pet tolerance is required.

SILENT OUTPUT



SAVER's new ECO PLATFORM Includes a silent non mechanical relay providing improved immunity to magnetic interferences and reducing sensor noise.

NOISE REDUCTION

SAVER's new digital intelligence reduces vulnerability to any RF noise and allows sharper sensitivity to be achieved.

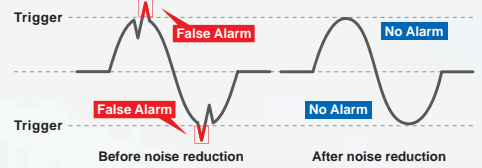

BASIC PERFORMANCE

ADVANCED SEALED OPTICS



ADVANCED TEMPERATURE COMPENSATION LOGIC

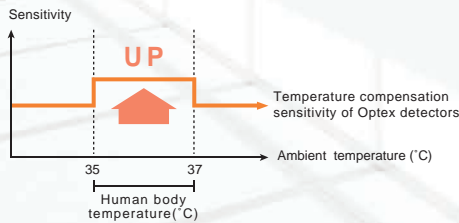

It automatically increases the detector's sensitivity under high temperature conditions, especially where the background temperature ranges from 35-37°C (63 - 67°F), close to that of the human body.

OPTION

18m long range lens : FL-60N

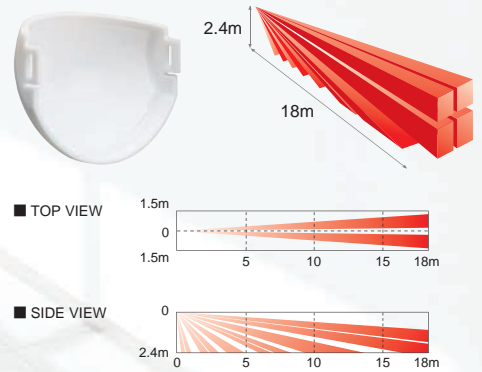

COVERAGE

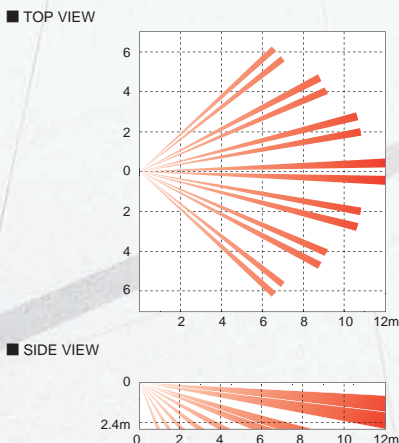

SPECIFICATIONS

Model	SAVER
Detection method	Passive infrared
Coverage	12m x 12m(40ft x 40ft) 85°wide
Detection zones	78 zones
Mounting height	1.5 to 2.4m (5 to 8ft)
LED alarm indicator	Switchable ON/OFF
Alarm period	Approx. 2.5 sec
Alarm output	N.C., 24VDC 0.2A max.
Tamper switch	N.C., Open when cover is removed.
Sensitivity/range	Switchable LOW/MID/HI
Warm up period	Approx. 30 sec
Power input	9.5 to 16VDC
Current draw	8mA(normal), 11mA(max.) at 12VDC
Dimensions	93.4mm x 61.4mm x 46.0mm <HxWxD>
Weight	Approx. 70g
Operating temperature	-20°C to +50°C(-4°F to +122°F)
Environmental humidity	95% max.
RF interference	No alarm 10V/m

※Specifications are subject to change without prior notice.

DIMENSIONS

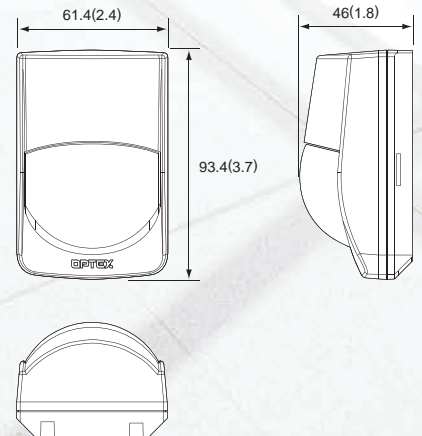

Unit:mm(inch)



OPTEX CO., LTD. (ISO 9001 Certified / ISO14001 Certified)
5-8-12 Ogoto, Otsu, Shiga, 520-0101 Japan
TEL +81(0)77 579 8670 FAX +81(0)77 579 8190 <http://www.optex.co.jp/e/>

OPTEX (EUROPE) LTD. (UK) <http://www.optex-europe.com/>
(ISO9001 Certified)

Platinum House, Cordwallis Ind Est
32B Clivemont Road, Maidenhead
Berkshire, SL6 7BU
Tel : + 44 (0) 1628 631000
Fax : + 44 (0) 1628 636311